

The Discovery and Science of Smart Meter Fires

Introduction to
the discovery of
Radio Frequency
Radiation (RF
Rad) and the
related
breakdown of
electrical wiring
insulation leading
to fire causation



Presented by

**Jim Brown, CCAI-CFI
Fire Forensics & Technology**

**Dr. Robert Armstrong, PhD P.E.
Armstrong Engineering**

**Dr. Vytenis Babrauskas, PhD
Fire Science and Technology Inc.**

NFPA[®] 921

Guide for Fire and Explosion Investigations

2021



Scientific Methodology

- Fire investigation requires the “global” responsibility to determine the origin of the fire and the fire cause. Utilization of this methodology is the age-old inductive and deductive reasoning process. This process is only as good as the thoroughness of the individual to examine possibilities and scientifically determine their probability in causation.
- Thus, the more information the investigator knows, the more hypotheses they can introduce into the inductive/deductive reasoning process, the better the result.
- The length and breadth of scientific knowledge and principles needed by the fire investigator is large in scope. Subject matter experts are generally required. These experts include crime scene examiners and evidence collection personnel, laboratory analysts, electrical/mechanical engineers and others.

Scientific Methodology...

- The pursuit of scientific analysis and discovery is a non-advocacy endeavor of the investigator. This applies to both criminal and civil fire investigation. The collection of data/evidence leading to the scientific conclusions are adjudicated/advocated in the legal system.
- As with the following investigation into the increase in and causation of, fixed wiring electrical fires, no blame is targeted to any specific agency or group. As you will see in this presentation, the investigation into the fire cause of the proliferation of fixed wiring fires followed scientific methodology to arrive at a probable causation theory.

“The Eyes will never see what the Mind does not know”

- This is the key to all scientific journeys and discovery. The more you know, the more you “see”.
- Therefore, your ability to hypothesize and test those hypotheses is only as good as your thorough knowledge of the subject at hand.
- Your “angle of perception” is as valuable as what you know. There are 360 different views of your evidence that makes up your final conclusion.

What the eyes saw that the mind did not know

- Every scientific discovery begins as a journey to find the truth of a confusing matter. This journey began to answer the question of electrically-caused fixed wiring fires that were beginning to exhibit a repeated modality not seen prior.
- Here is an example of the fire problem:

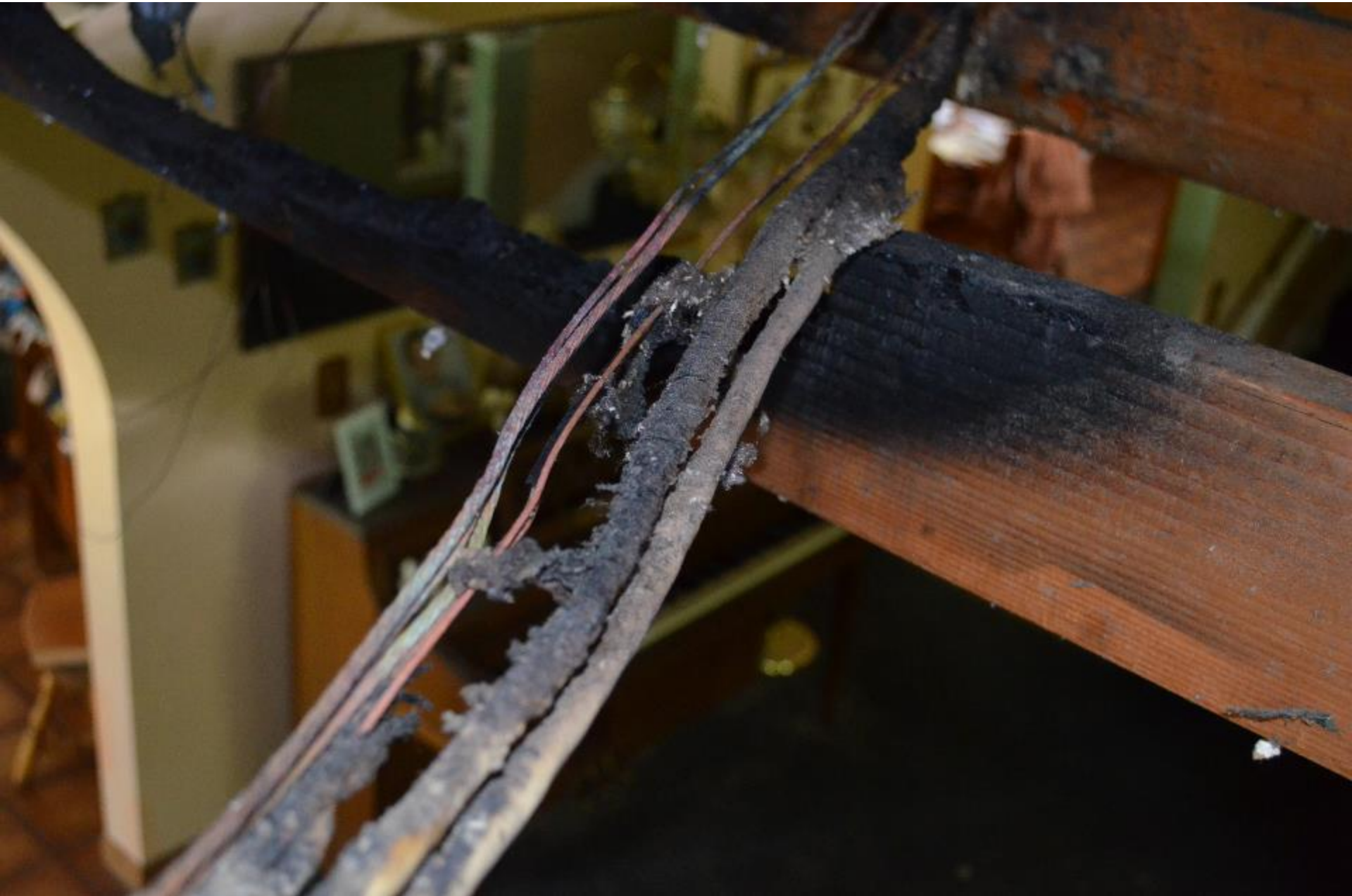



Resistive heating of Romex electrical conductors in mid span run

- Fixed electrical wiring fires are often caused by connection point failures over time at junction boxes or wire- nut connections. These failures result in arc faulting and resistive heating.
- Mid-span electrical fires may be attributable to a hard-driven staple that over time causes the insulation to be compressed. These failures result in resistive heating fires.
- Resistive heating from an electrical conductor does not cause the circuit breaker protection to trip, resulting in localized electrical heat energy to the wood structural member nearby. This heating causes slow pyrolytic damage to the wood that can eventually result in flaming combustion.

Smart Meters and the “Smart Grid Initiative”

- Allows two-way real time communication between utility company and end user (“customer”) using radio frequency (RF).
- Transmits usage data based upon the settings selected by utility company. Numerous variables include:
 - Modulation Signal strength
 - Frequency Similar to Wi-Fi and cellphone but with greater power
 - Daisy chains Data from meter to meter covering up to 750 locations

Electric Utility Power Distribution Systems

New Definition of Grid Now Includes “Customer Equipment”

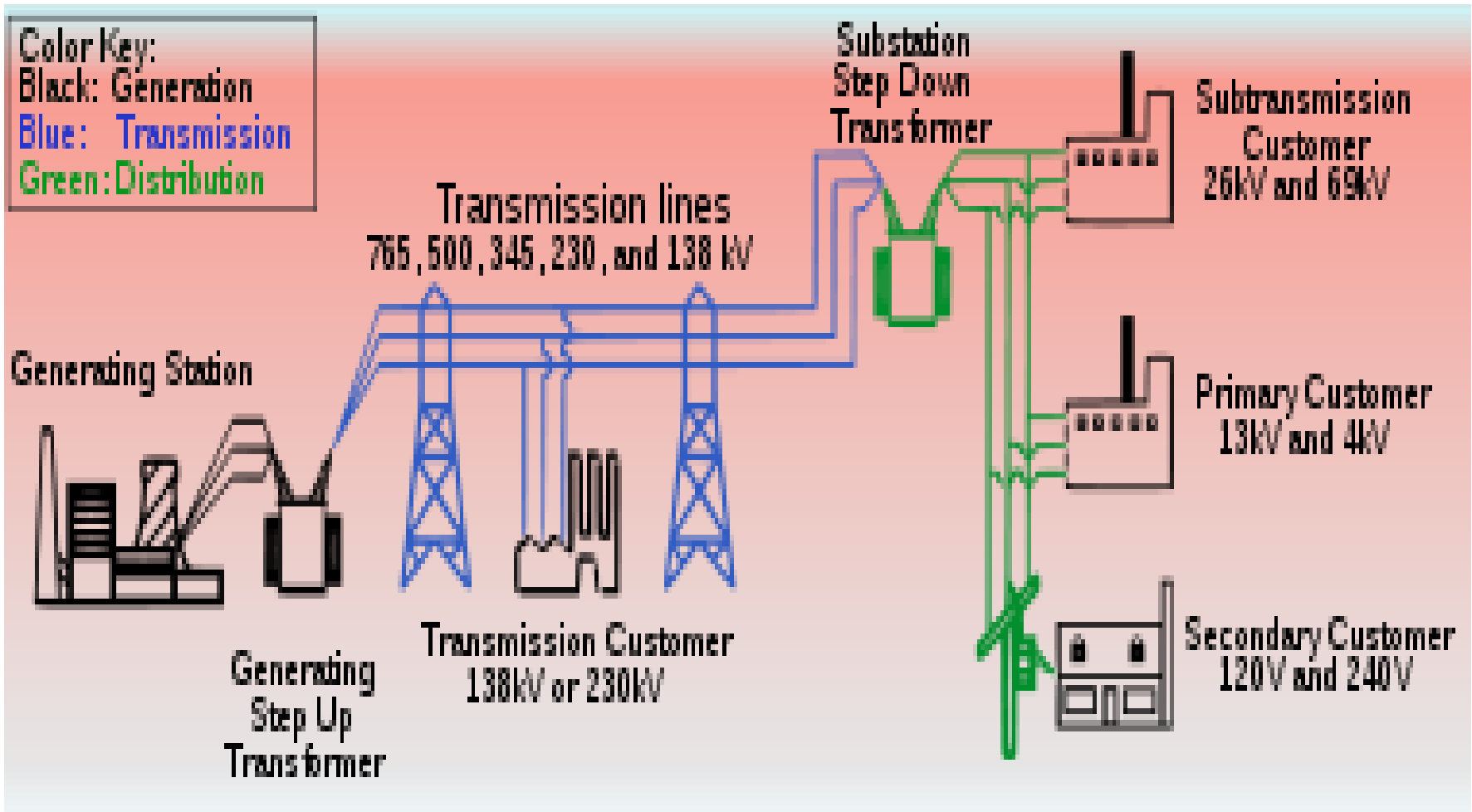



Digital Smart Meter



Collector or “Super Meter”



Sends Signals to WAN Antenna





Mesh network communications

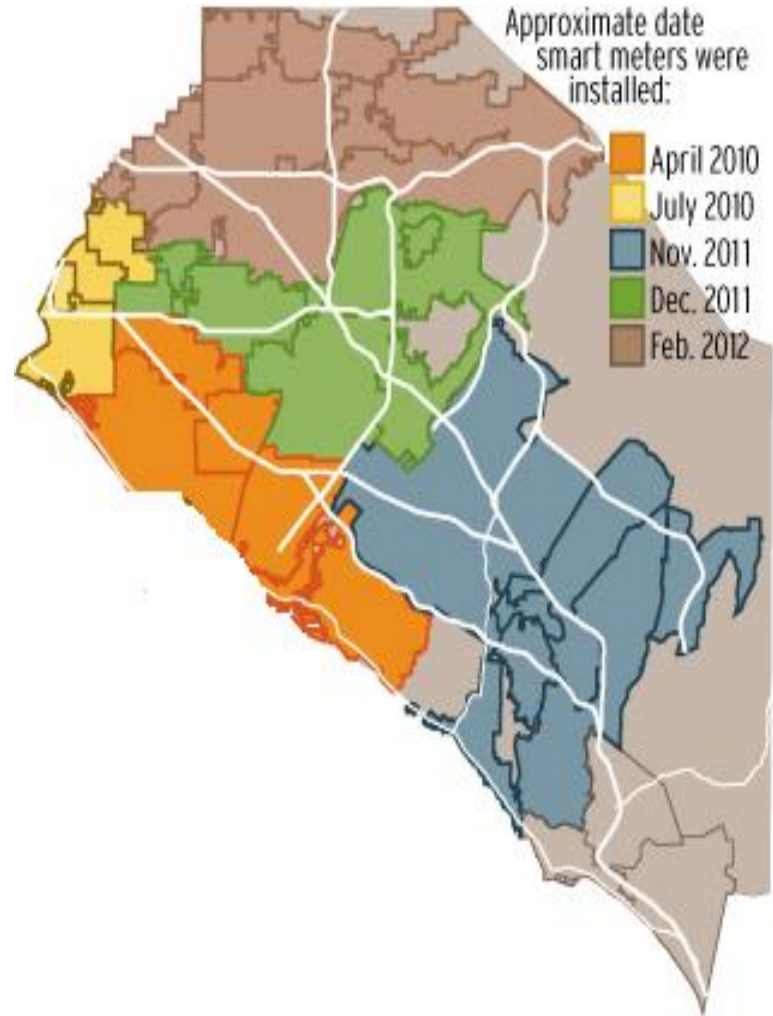
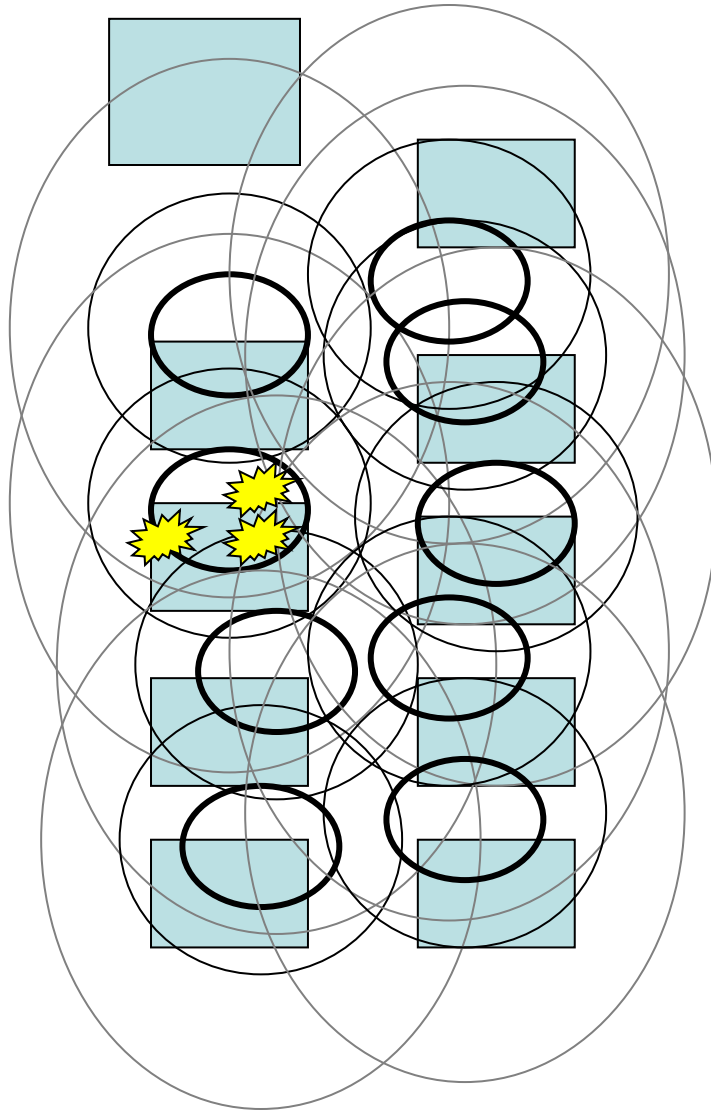



Typical Fires Resulting From Wiring Breakdown



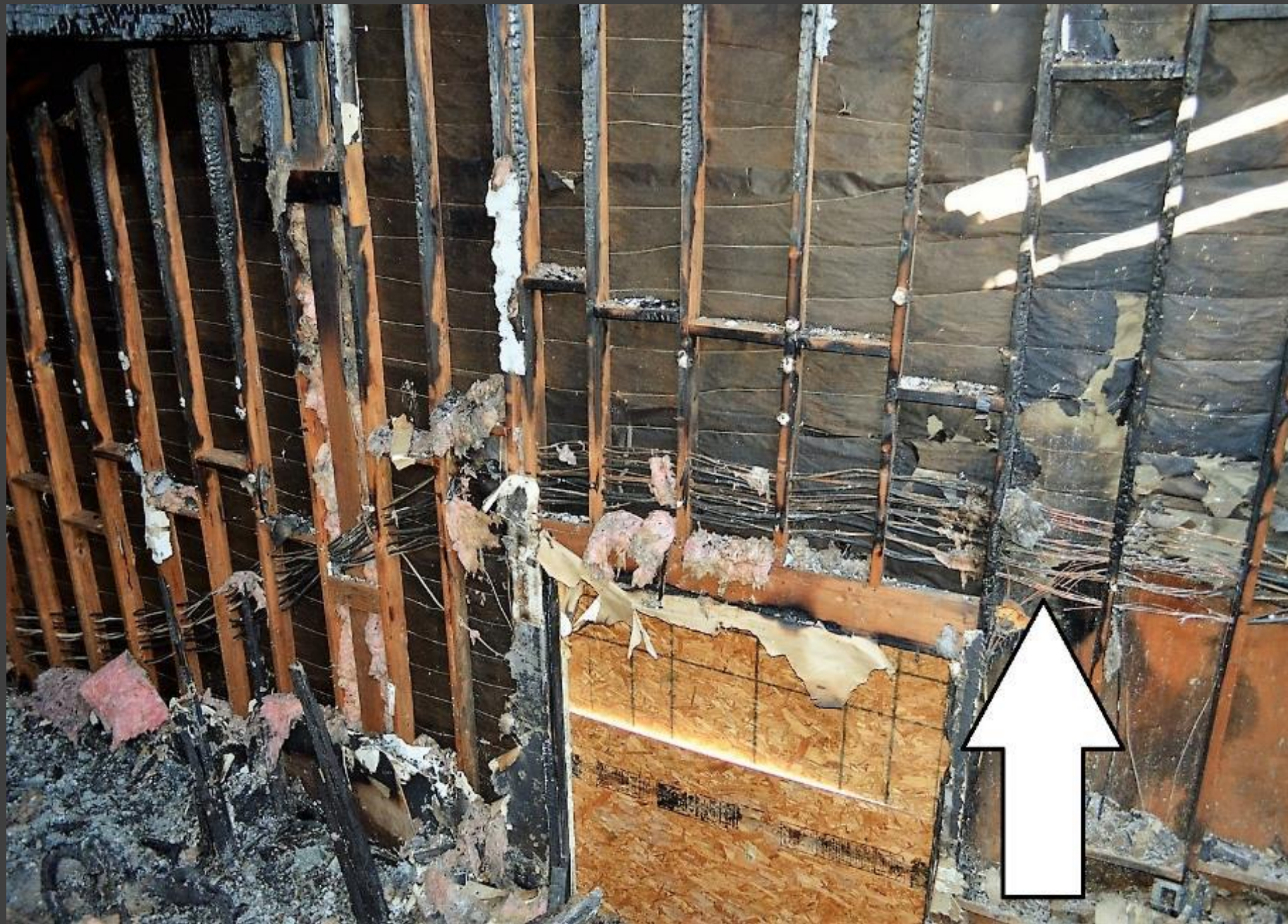



Characteristics of smart meter fires from field observation

- Occur within 1 month to two years following initial replacement of analog meter with smart meter
- Within 15 – 25 feet of smart meter
- Occur in continuous sections of branch circuit wiring, not at points of connection or splices, not near staples, not in junction boxes
- No evidence of insect or rodent infestation
- Occur in void spaces (walls, ceilings) and in attics with no human activity
- Often small fires (5 – 10' diameter)
- No correlation to service size or circuit loading
- No correlation to premises wiring age or material (Al or Cu)
- No correlation to significant weather events (lightning)
- No evidence of utility supply (distribution) system anomalies (voltage spikes)
- Fires cause typically listed as UNDETERMINED

5 Stages Leading to Fire...

- **1st Stage:** RF pulses (beams) away from meter in a specific pattern to send signals (data) to nearby meters in the “Daisy Chain”.
- **2nd Stage:** RF from meter bounces off “reflected” surfaces causing RF to “double/quadruple” in intensity (in terms of energy density measured as microwatts per square meter; $\mu\text{W}/\text{m}^2$). The pulse bounces back and onto the oncoming pulse and intersects at a specific geometric focal point. If PVC insulation is present at that focal point, the RF energy can get converted to heat energy in the dielectric, causing micro fractures or bubbles in the polymer. The main effect is likely thermal, but the existing electric field may accelerate the degradation of the polymer (PVC).

5 Stages (cont.)

- **3rd Stage:** Sufficient heating can either ignite the polymer directly, or, more likely, first carbonize it. If PVC gets carbonized, then this can be the initiation of arc tracking, and arc tracking can end up in ignition.
- **4th Stage:** If wood structural members are near/touching, this resistive heating can initiate and sustain pyrolysis of wood.
- **5th Stage:** Flaming combustion begins.

New Scientific Discovery?

- Breakdown/destruction of wiring insulation due to RF radiation was first encountered by the DoD (Navy/Air Force) when radar was utilized. They encountered numerous fires to the electrical wiring onboard ships and airplanes. Steps were taken to produce an “RF resistant” insulation material to prevent the breakdown.
- Ignitions from military radar equipment were first observed in the early 1940s. But it is surprising how little literature can be found on the phenomenon.
- Below are some of the very few citations found in the published literature.

US Navy report, 1957

ELECTRONIC POTENTIAL — Lockheed Aircraft Corporation, having conducted actual tests with the AN/APS20 E Radar, has come up with the following findings:

- It ignited dry steel wool at a distance of 45 feet.
- It caused sparking among a mixture of aluminum chips which exploded a gasoline vapor-air mixture at a distance of 251 feet.
- It set off photo flash bulbs at a distance of 850 feet.
- It caused audible and visible sparking among metallic chips shaken in a paper bag at a distance of 275 feet.
- Pronounced humming was produced by medium aluminum wool at 300 feet.

Fueling and defueling operations should not be conducted within 275 feet of the radar beam,

US Navy report, 1958

RADAR RADIATION CAUSES FIRE—Returning from a routine flight, a ZPG-2 experienced what seemed to be an electrical fire. In-flight investigation indicated that the fire came from below the deck adjacent to the main inverter.

The deck plates were removed and CO₂ was discharged into the radome. Shortly thereafter the fire subsided. The airship returned to base and made a normal landing.

Later, removal of the radome fairing showed that oil from the bilge had seeped between the radome and the fairing and had accumulated in the low spot between them. A pair of pliers, a 1.5-volt battery, and several small pieces of wire were also found in this area. Charred portions of the radome and fairing described the path of the fire.

Investigation indicated that the fire was located in the dead space bounded by the car bilge bottom, the radome, and the after radome fairing. It was determined that the fire exhausted itself of oil and/or air and the discharged CO₂ did not reach the area.

Such objects as steel wool and aluminum chips can be set afire by the radiation pattern of this

Hypothesis or Fact?

- This hypothesis has been tested with a post-fire NM cable (“Romex”) submitted for analysis to a well-respected materials laboratory. The conclusions yielded positive results of bond dissociation causing the breakdown of the PVC insulation material near the point of the resistive-heating-caused fire event.
- The analysis found molecular breakdown in PVC insulation that could have only been caused by RF radiation. The resulting breakdown compromises or destroys the insulating properties of PVC.

National Fire Statistics on Fixed Wiring Fires

- The following graphs were taken from an NFPA study dated September 2017. Please note the spike nationally on electrical fires to fixed wiring during 2012-2015, the time when most of the Smart Meters were initially installed and put into operation.

Electrical fires in the US for 2002 – 2016 (Source: NFPA)

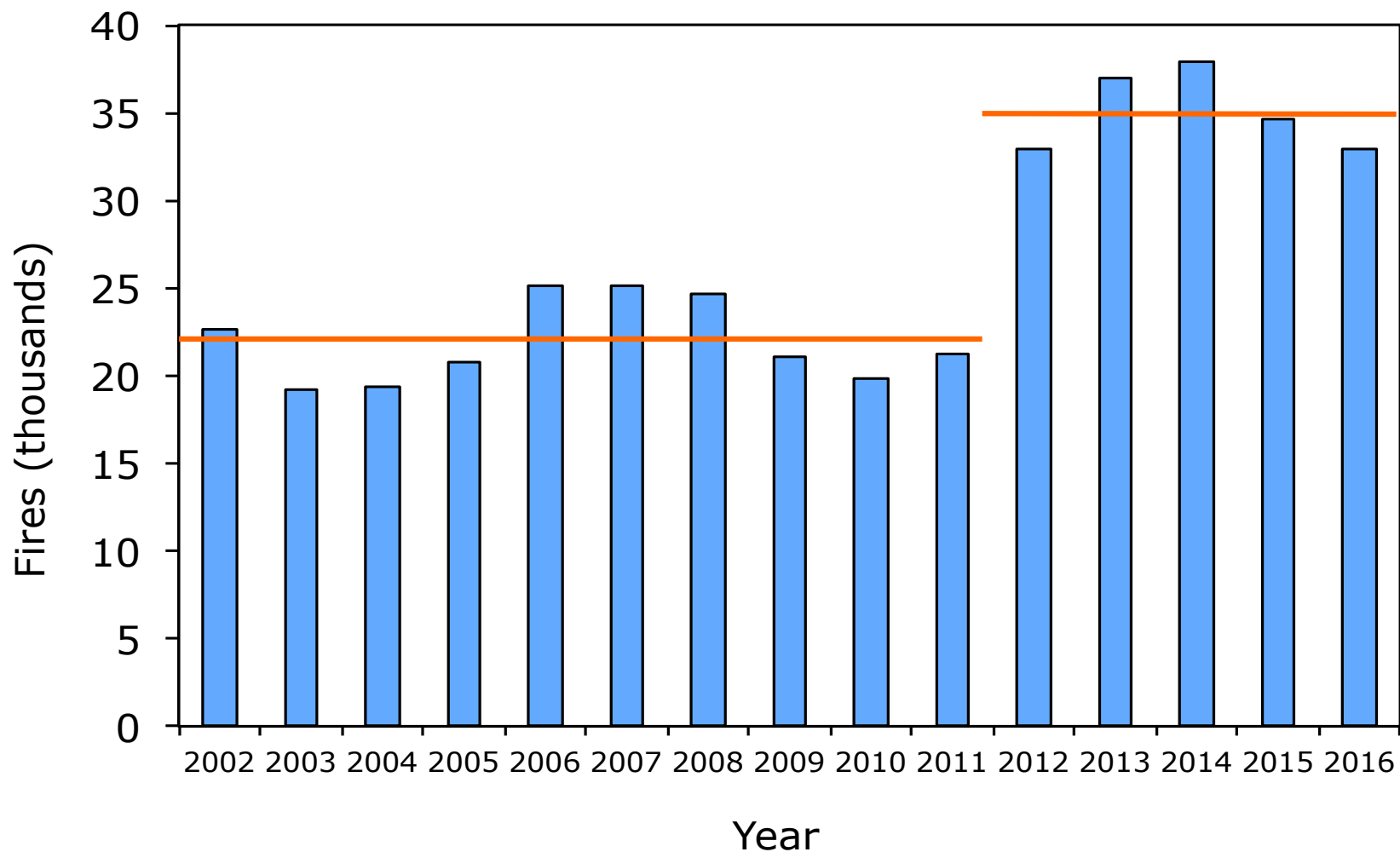

Figure 15. Home Electrical Distribution or Lighting Fires and Deaths, by Year

Figure 15A. Fires

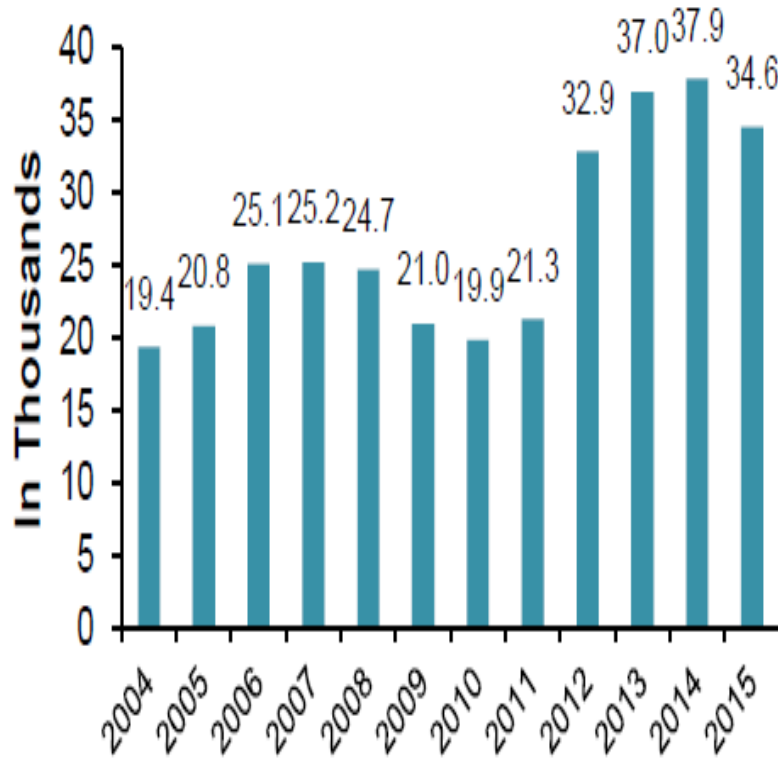
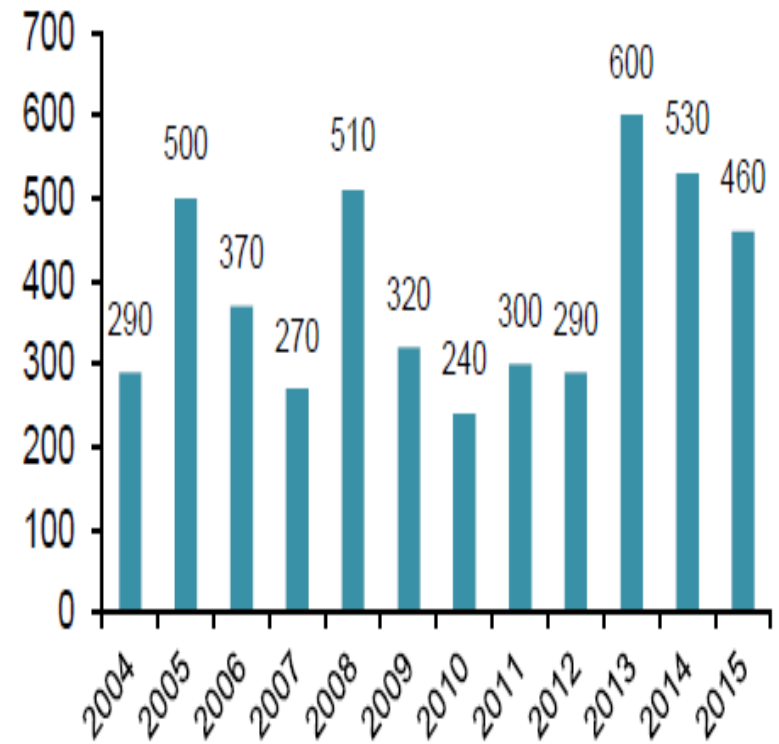

Figure 15B. Civilian Deaths



What the statistics indicate

- The number of fixed wiring fires in the U.S. during 2002 – 2011 was approximately 22,000. For the next 5 years, the number rose to 35,000 or a 59% increase.
- The figures tend to suggest the presence of some specific change in conditions that would cause such a jump. For fixed wiring that is hidden in walls and ceilings, the possibility of accidental damage of the PVC insulation is remote. For any given case, this can be ruled out by examining for staple damage or mechanical damage.
- Utilizing the Scientific Method, the question to all who examine fires is simple: What is the cause of this deadly spike?

If not this, then what?

- This investigation has taken several years to discover, theorize, analyze, test and conclude without prejudice or agenda. The scientific team assembled to examine these large number of fires has explored every known scientific possibility and reason. Leaving only one question: If not this, then what...
- The fire investigator has one primary mission, to DETERMINE the origin and cause of fires. As you have seen, the number of a specific electrical fire classification has spiked greatly. Therefore, staying “on mission” requires an answer to this proliferation.
- The team continually invites any new possibilities...

Video compilation of arcing sound prior to flaming combustion

- Sound emission captured on radio band as “static” for hours preceding a fire caused by arc tracking prior to eruption of flaming combustion.

CH 14



2017/01/21 10:40:44
1920x1080 10.0M X1



Dr. Babrauskas Discussion and Final Notes

Types of smart meter fires

Smart-meter-caused fires can be grouped into three broad categories:

- 1) **Inadequate mechanical or electronic design of the meter.**
 - Example: Overheating component(s) inside meter; water ingress into electronics due to poor sealing; inadequately-sized shut-off relays causing fire upon remote re-energization; faulty Li-ion batteries (note that mechanical meters do not need one).
- 2) **Problems at the meter/base stab connections.**
 - This has nothing to do with the “smart” aspects. Usually due to an untrained gorilla force-fitting the new meter onto the base.
- 3) **Ignitions of wiring at some distance from the meter.**
 - This is the sole topic of our presentation today. #1 and #2 are fairly well understood and not particularly controversial.

Research is needed...

- On PVC failure mechanisms due to RF heating
- On RF fields created due to smart meters
- However, we can start by considering what we do know now:

Some important regions of the EM spectrum

Spectral region	Wavelength (m)	Frequency (Hz)	Energy (eV)
RF	$> 10^{-3}$	$< 300 \text{ GHz}$	$< 1.24 \times 10^{-3}$
microwave	$10^{-3} - 0.3$	$1 \text{ GHz} - 300 \text{ GHz}$	$4.1 \times 10^{-6} - 1.24 \times 10^{-3}$
IR	$7.6 \times 10^{-7} - 10^{-3}$	$300 \text{ GHz} - 30 \text{ THz}$	$1.24 \times 10^{-3} - 0.124$
visible	$3.8 \times 10^{-7} - 7.5 \times 10^{-7}$	$4.0 \times 10^{14} - 7.9 \times 10^{14}$	$1.61 - 3.26$
UV	$10 \times 10^{-9} - 3.8 \times 10^{-7}$	$7.9 \times 10^{14} \text{ Hz} - 3.4 \times 10^{16} \text{ Hz}$	$3.26 - 141$
ionizing radiation	$< 1.24 \times 10^{-7}$	$> 2.42 \times 10^{15} \text{ Hz}$	> 10

RF heating

- Also called dielectric heating
- Old medical example: diathermy machines
- If it is in the microwave region, then it is called microwave heating

...Research...

- It is sometimes thought that, when RF fields are involved, one needs **ionizing radiation** in order to ignite or destroy a plastic.
- This is a fallacy. Ionizing radiation is of such huge frequencies (small wavelengths) that it only is found near nuclear reactions or in high-energy physics labs.
- Instead, normal microwaves (such as emitted by smart meters) can damage or destroy plastics due to **dielectric heating**.

...Research...

- An electric convection oven works in the visible/IR spectrum, yet try sticking in a piece of PVC wiring in there and turn it up to 550°F!
- The microwave portion of the spectrum shows only slightly lower eV values, which are also way below the 10-eV minimum to constitute ionizing radiation.
- Destruction is not due to ionizing, but simply due to thermal heating.

Bond breakage...

- Ionizing radiation will normally not be encountered in practical conditions.
- But there is an intermediate mechanism between ionizing radiation and dielectric heating: **bond dissociation**.
- To break a C-Cl bond requires about 350 kJ/mol, which is equal to 3.5 eV.
- Whereas to *ionize* a molecule, the energy required is often in the range 8 – 12 eV.

...Bond breakage

- Microwave heating regime is below the 3.5 eV (and is, in fact, below 1.24×10^{-3} eV)
- But this just means that a single photon is not energetic enough to destroy a single chemical bond.
- It does not say that cumulative input energy from the microwave spectrum will not overheat the plastic, degrade it, char it, and then maybe ignite it.

...Research...

- Dielectric heating, if sufficient in magnitude, can damage polymers
- The polymer (PVC here) gets damaged by an excessive temperature rise.
- The excessive temperature rise breaks some chemical bonds and creates others (cross-linking)
- The net result manifests as charring.
- You don't need ionizing radiation for this, you just need to put in enough heat.

Microwave heating

- Cellphones and microwave ovens are both very convenient modern electronic devices.
- But you should not put your cellphone in your microwave oven. If you do, get this:



*Photo:
Nam-Kyu Park*

Heating in microwave oven

- Note where the damage occurred to the flip-phone: near the hinge.
- The hinge is the single biggest metal object inside this particular model of flip-phone.

Fundamental dielectric heating equation

$$P = 2\pi\nu\varepsilon\varepsilon_0\mathcal{E}^2 \tan \delta$$

where

\mathcal{E} = electric field (V m^{-1})

P = power absorbed per unit volume of dielectric (W m^{-3})

ε = relative permittivity (--),

ε_0 = permittivity of free space ($8.845 \times 10^{-12} \text{ F m}^{-1}$)

$\tan \delta$ = loss angle (--).

Sometimes also define for convenience a dielectric heating coefficient, J (--):

$$J = \frac{1}{\varepsilon \tan \delta}$$

Dielectric heating coefficient

Material	J (–)	
phenol formaldehyde	1.0 – 1.9	worse ↑ ↓ better
melamine formaldehyde	2.4	
urea formaldehyde	3.8	
PVC	20	
ABS	40	
polyethylene	1100	
polystyrene	1330	

- So, PVC is not the worst...but it's bad enough

Dielectric heating equation

- The equation is fairly simple, but *using* it may not be simple.
- Primarily since ϵ and $\tan \delta$, vary with both frequency and temperature.

PVC temperature dependence of $\tan \delta$

- This is only applicable to 2.4 GHz; data for other frequencies are hard to find.
- Smart meters radiate in the 2.45 GHz band, but also 900 MHz and CDMA bands (850, 1900 MHz).

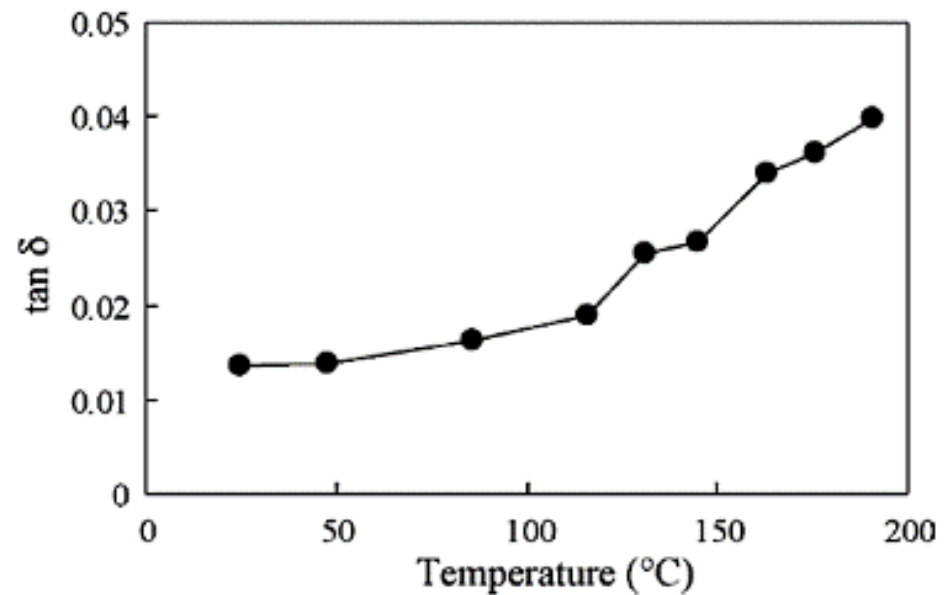

Combined temperature and frequency effect

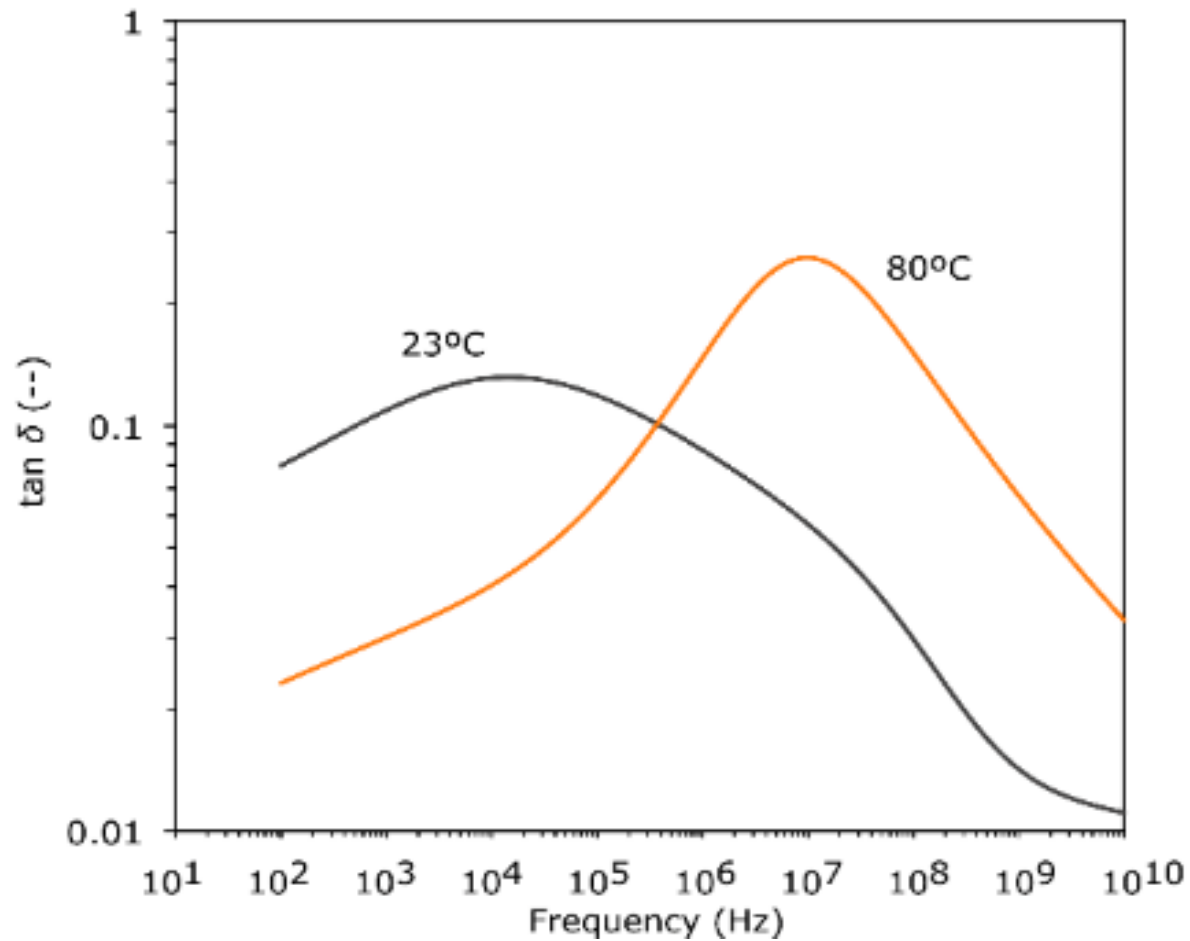

Microwave-metal interaction pyrolysis...

- This is a relatively new area of scientific study.
- While PVC has not yet been studied, work with some other polymers shows that the presence of metal in/at/near the polymer which is in a microwave field can greatly enhance the heating process.

...Microwave-metal interaction pyrolysis

- Gasner, L. L. Denloye, A. O., and Regan, T. M., Microwave and Conventional Pyrolysis of a Bituminous Coal, *Chem. Eng. Commun.* **48**, 349-354 (1986).
- *“The presence of the two parallel copper wires led to a concentration of microwave energy within the coal mass and the wires in effect acted as antennae for microwaves.”*

Reflection loss in thin layers...

- Some studies exist on microwave losses due to reflections within thin layers, notably at $\frac{1}{4} \lambda$ and $\frac{3}{4} \lambda$.
- This effect shows sharp peaks localized at a specific frequency.
- Some experimental data from Duan.
 - Duan, Y., Wu, G., Gu, S., Li, S., and Ma, G., Study on Microwave Absorbing Properties of Carbonyl-Iron Composite Coating Based on PVC and Al Sheet, *Applied Surface Science* **258**, 5746-5752 (2012).

Reflection loss in thin PVC layers

Layer thick. (mm)	Absorption peak (GHz)
1	5
2	4
3	2.6

“Non-thermal” microwave effects...

- For quite a long time, various studies have noted that microwave heating can—under some circumstances—provide more apparent heating, and greater rate of chemical reactions, than seems explainable by simply viewing the microwaves as a thermal energy source.

...“Non-thermal” microwave effects...

- This has proven perplexing to chemists, not just engineers. See for example, R. Dagani (1997).
- The simplest cause is the propensity for MW-heating to cause hot spots. This is very well known (why do you think the tray rotates in your MW oven?), but not always fully understood. Hot spots due to nonuniform external fields are well-understood, but hot spots due to the material’s own response, less so.
- Hot spots are a “thermal” cause; other causes are termed “non-thermal.”

...“Non-thermal” microwave effects...

- A more “chemical” explanation is MW-induced alignment of dipolar reacting molecules or groupings, also called *MW-forced tightening* of opposite polar heads of co-reacting groups. (Parodi, 1999). Or, storage of MW energy in the vibration-energy modes of the molecule (Peng, 2015).
- Other causes can include dielectric and crystal lattice polarization, electronic and ionic conduction, eddy current circulation, and interfacial polarization at grain boundaries (Parodi, 1999).

...“Non-thermal” microwave effects

- Possibly also, non-thermal MW effects are due to direct lowering of activation energy of some reactions (Xu, 2015; Ahirwar, 2016). This is an active debate area in chemistry, and the issue is unsettled.

The role of standards

- With most electrical devices, the public expects that there will be engineering standards which prevent fires and electric shock injuries.
 - But with smart meters, the situation is unusual.
- IEEE Std 1377, IEEE Std 1701, IEEE Std 1702, IEEE Std 1703, and IEC 62056 standards exist. But they only deal with data-interchange issues, not device safety.
- Way after the initial wave of smart meter rollouts, in 2014, UL first issued UL 2735, which is the first standard to contain some safety provisions.
 - BUT, compliance is not required. And there is no indication at this point if this standard is preventing fires.

Current status

- The above has been a “brainstorming” output on the problem.
- Hypotheses have been considered, but need experimental examination (or, in some cases, checking against existing research work).
- The problem is very real, so now must come some concerted study to unravel the details.

How could things be fixed?

- It appears that the bulk of the problem may be due to the fact that RF (MW) power is directly coupled into wiring.
- An external antenna, used instead, would alleviate much of this.
- Models of smart meters are available with external antennas.
- Some countries (Italy, Portugal) require external antennas, with the antennas to be mounted above roof-level.

Breaking news !!!

- Brand new book, **Electrical Fires and Explosions**, will be released in about 2 weeks.
- 1300 pages
- Bigger than the **Ignition Handbook**
- Only sold in hardback; only on www.doctorfire.com web store.
- More information there on smart meter fires, plus all things electrical.

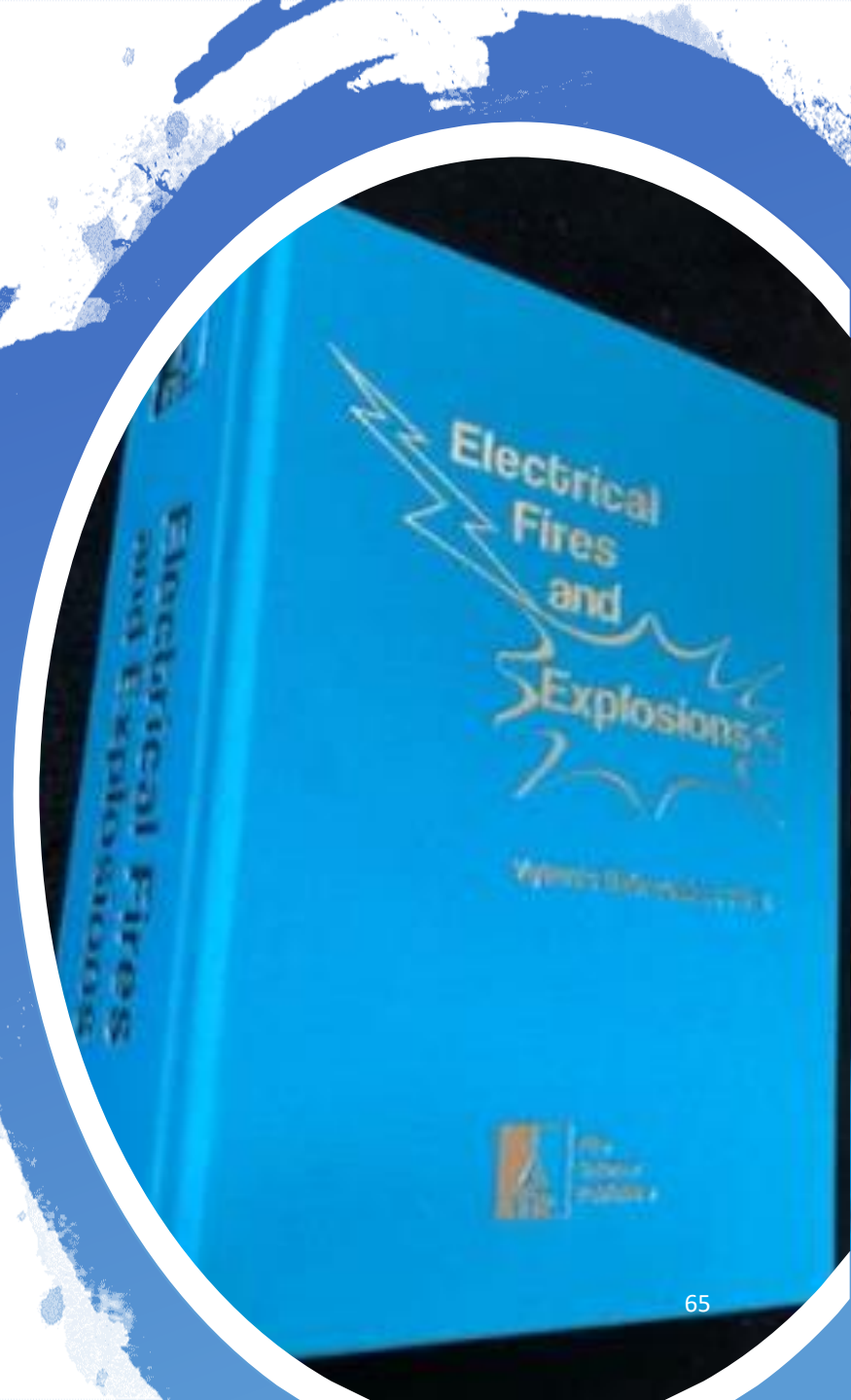



The end